

SUPER-EGO

Tarif Général

2024 



Indice

	Page
Équipements et outils pour tube	3
Services généraux	12
Soudage	15
Équipements et outils pour HVAC&R	17
Jardin et Camping	19

Conditions de Vente et Garantie

Tarif valable jusqu'au 31 décembre 2024. Celui-ci annule et remplace les précédents.

Tarifs P.V.P. recommandés, libre d'impôt. Tarif sujet à modifications sans préavis et en pouvant contenir des erreurs typographiques, des inexactitudes ou des omissions.

Conditions d'expéditions:

1. Le **montant minimum** de la commande est fixé à **400 € net H.T.**
2. Le franco est accordé pour toutes commandes **livrées d'un montant supérieur à 400 € net H.T.**
Toute commande et reliquat en dessous de 300 € net H.T seront susceptibles d'être annulés sans que le destinataire en soit averti.
3. Les **commandes doivent être envoyées** à l'adresse d'e-mail: **super-ego.france@super-ego.es.**

Conditions de Garantie:

1. **Tous les produits SUPER-EGO bénéficient d'une garantie à vie, contre tout vice de matériaux et de fabrication pour la durée de vie du produit.**
2. SUPER-EGO s'engage à remplacer ou échanger tout produit pour lequel les matériaux ou la fabrication ont été jugés défectueux suivant le critère ou cahier des charges SUPER-EGO.
3. Tout produit défectueux, accompagné d'une preuve d'achat et par accord écrit, **doit être expédié à SUPER-EGO Ctra. Durango-Elorrio, km. 2 - 48220 Abadiano (ESPAGNE)** suivant la procédure qui vous sera envoyée sur demande.
4. Tous les produits sont couverts par la garantie à vie, **sauf pour l'outillage électrique ou électronique, le délai de garantie pour ses produits est de 1 an.**
5. SUPER-EGO exclut de cette garantie les défauts causés par une mauvaise utilisation, la négligence ou le mauvais entretien du produit.
6. **SUPER-EGO vous conseille l'utilisation de pièces de recharge propres à SUPER-EGO.** Pour vous assurez la qualité originale du produit, afin de prolonger sa durée de vie ainsi que sa garantie.

No.	Description	Prix €
-----	-------------	--------

**102 Clé Heavy Duty**

1000001639	6"	10,75
102080000	8"	27,45
102100000	10"	35,40
102120000	12"	40,70
102140000	14"	45,55
102180000	18"	64,70
102240000	24"	102,75
102360000	36"	227,35
102480000	48"	432,05
1000001638	60"	558,40

**112 Clé Heavy Duty coudée**

112100000	10"	40,75
112140000	14"	56,20

**122 Clé Heavy Duty "ECO"**

SE1220800	8"	23,35
SE1221000	10"	28,95
SE1221200	12"	31,35
SE1221400	14"	37,30
SE1221800	18"	49,55
SE1222400	24"	64,10

**101 Clé Stillson**

101080000	8"	26,25
101100000	10"	29,70
101120000	12"	33,90
101140000	14"	40,10
101180000	18"	55,30
101240000	24"	87,95
101360000	36"	255,00

**121 Clé Stillson ECO**

121080000	8"	19,15
121100000	10"	22,55
121120000	12"	24,35
121140000	14"	27,50
121180000	18"	36,45
121240000	24"	48,30

**104 Clé alliage léger en aluminium**

104100000	10"	48,55
104140000	14"	64,60
104180000	18"	79,05
104240000	24"	122,60
104360000	36"	246,75
70164	48"	492,75
1000001640	60"	474,70
PO1100100	Set 14" + 18"	141,10

No.	Description	Prix €
-----	-------------	--------

**105 Clé en aluminium coudée**

105140000	14"	69,85
105180000	18"	92,70

**145 Clé suédoise "S"**

145050000	1/2"	31,15
145100000	1"	36,65
145150000	1.1/2"	52,15
145200000	2"	84,35
145300000	3"	147,70
P14534300	1" + 1.1/2"	105,65

**141 Clé suédoise 90°**

141100000	1"	40,05
141150000	1.1/2"	57,15
141200000	2"	92,35
141300000	3"	195,85

**143 Clé suédoise 45°**

143050000	1"	34,05
143100000	1"	40,05
143150000	1.1/2"	57,15
143200000	2"	91,25

**145 Clé suédoise ECO "S"**

1000000503	1/2"	22,15
1000000504	1"	26,40
1000000505	1.1/2"	37,50
1000000507	2"	59,35

**540 Clé pique-filetage**

540010000	3/8"	71,60
-----------	------	-------

**123 Clé à sangle**

123010000	20-200 mm Ø	150,45
123021000	Sangle de recharge	17,00

**108 Clé à sangle**

108010000	3"	46,95
108020000	8"	48,25
70268	Sangle de recharge 3" (435 mm)	17,85
70269	Sangle de recharge 8" (950 mm)	19,55

No.	Description	Prix €
-----	-------------	--------

**107 Clé à chaîne réversible**

107120000	12"	49,55
70239	Chaîne de recharge 4" (439 mm)	39,80

**103 Clé à chaîne**

103300000	1.1/2"	82,65
103310000	2.1/2"	142,15
103320000	4"	200,60
103330000	6"	404,85
103340000	8"	532,30
103350000	12"	978,05

**118 Clé lavabo**

118010000	3/8-1.1/4"	38,40
-----------	------------	-------

**109 Clé lavabo**

109010000	3/8-1.1/4"	34,10
-----------	------------	-------

**117 Clé lavabo télescopique**

117010000	3/8-1.1/4"	50,15
117480000	3/4-1.7/8"	58,30

**524 Pince multiprise à branches entrecroisées**

520070000	7"	17,35
524100000	10"	18,30
524120000	12"	26,55
S00210000	Présentoir de table 524 (10")x12"	219,05

**522 Pince multiprise à branches entrecroisées**

522070000	7"	19,00
522100000	10"	19,35
522120000	12"	29,50
S00220000	Présentoir de table 522 (10")x12"	224,10

**509 Pince multiprise à cran**

509090000	10"	24,10
509120000	12"	33,00
509160000	16"	55,35

1

No.	Description	Prix €
-----	-------------	--------



Clé à molette à ouverture extra-large		
1500000670	L: 8" / Ø 0-38 mm	15,65
SEH019200	L: 10" / Ø 0-50 mm	22,10



135 Clé à molette		
135060000	L: 6" / Ø 19 mm	14,00
135080000	L: 8" / Ø 24 mm	15,10
135100000	L: 10" / Ø 30 mm	20,05
135120000	L: 12" / Ø 34 mm	25,60
135150000	L: 15" / Ø 44 mm	43,75



507 Tenaille russe		
50709C000	9"	15,60
50710C000	10"	16,65

Branches plastifiées		
507090000	9"	16,90
507100000	10"	13,50
S00230000	Display 507 (9") x 12	206,35



508 Tenaille russe automatique		
508090000	9"	19,45
508100000	10"	25,60



400 Étau à chaîne		
400010000	2.1/2"	115,80
400020000	4"	166,30
400030000	6"	269,45



404 Étau à chaîne		
404020000	2.1/2"	173,70
404040000	4"	250,65
404060000	6"	366,50



450 Étau à charnière		
450020000	2"	144,45
450030000	3"	248,05
450040000	4"	324,30

No.	Description	Prix €
-----	-------------	--------



462 - 463 Établi Tristand		
462000000	Tristand bench	272,80
463000000	Établi Tristand avec plaque à cintrer	311,05
463100000	Établi Tristand avec plaque à cintrer + mors 450 (2")	457,25



464 Établi Tripode (plaque en aluminium)		
464000000	464	579,60
464003000	464 + 400 (2.1/2")	683,60
464003100	464 + 400 (4")	738,15
464003400	464 + 400 (2")	715,90
464020000	464 + 404 (4")	817,55
464030000	464 + 404 (6")	931,35
464010100	Vis pour mâchoires	457,25



Établi tripode avec Etau 6"		
1500000530		569,55



600 Sets PROMO		
600240600	1/2"-1.1/4" BSPT	320,25
600240900	1/2"-1" BSPT	254,50
600243900	1/2"-1" NPT	213,95



600 Sets Compact		
600220500	3/8"-1.1/4" BSPT	393,10
600220600	1/2"-1.1/4" BSPT	348,25
600220800	3/8"-1" BSPT	332,30

No.	Description	Prix €
-----	-------------	--------

600220900	1/2"-1" BSPT	273,35
600223500	3/8"-1.1/4" NPT	404,60
600223600	1/2"-1.1/4" NPT	348,25
600223700	1/4"-1" NPT	388,45
600223800	3/8"-1" NPT	332,30
600223900	1/2"-1" NPT	273,35



600 Set professionnel		
600230000	1/4"-2" BSPT	509,75
600230100	3/8"-2" BSPT	708,10
600230200	1/2"-2" BSPT	653,40
600230400	1"-2" BSPT	557,35
600230500	1.1/4"-2" BSPT	490,35
600230600	1.1/2"-2" BSPT	383,15
600233100	3/8"-2"	728,90
600233200	1/2"-2"	672,65
600233300	3/4"-2"	616,30
600233400	1"-2"	557,35
6002M0000	(conduit) 16-20-25-32 mm	367,00



S00 Le nécessaire du plombier		
S00750000	Avec 102 - 14"	363,30
S00630000	Avec 145 - 10"	363,30



Têtes de filières		
6002D0000	1/4" BSPT	57,45
6003D0000	3/8" BSPT	55,75
6004D0000	1/2" BSPT	55,75
6005D0000	3/4" BSPT	55,75
6006D0000	1" BSPT	64,90
6007D0000	1.1/4" BSPT	68,75
6008D0000	1.1/2" BSPT	117,90
6009D0000	2" BSPT	117,90
6002N0000	1/4" NPT	57,45
6003N0000	3/8" NPT	57,45
6004N0000	1/2" NPT	57,45
6005N0000	3/4" NPT	57,45
6006N0000	1" NPT	66,85
6007N0000	1.1/4" NPT	70,80
6008N0000	1.1/2" NPT	117,90
6009N0000	2" NPT	117,90

No. metric P1,5 mm		
6002M0000	Metric set 16,20,25,32 mm	367,00
6000M1600	16 mm	66,85
6000M2000	20 mm	66,85
6000M2500	25 mm	66,85
6000M3200	32 mm	64,85

No.	Description	Prix €
-----	-------------	--------

**Jeu de peignes**

6002D4000	1/4" BSPT	38,35
6003D4000	3/8" BSPT	38,35
6004D4000	1/2" BSPT	38,35
6005D4000	3/4" BSPT	38,35
6006D4000	1" BSPT	38,35
6007D4000	1.1/4" BSPT	38,35
6008D4000	1.1/2" BSPT	61,55
6009D4000	2" BSPT	61,55
6002N4000	1/4" NPT	38,35
6003N4000	3/8" NPT	38,35
6004N4000	1/2" NPT	38,35
6005N4000	3/4" NPT	38,35
6006N4000	1" NPT	38,35
6007N4000	1.1/4" NPT	38,35
6008N4000	1.1/2" NPT	61,55
6009N4000	2" NPT	61,55

**Manches**

600000000	1/4"-1.1/4" Ø	89,70
600010000	1.1/2"-2" Ø	143,00

**Alésoir**

785200000		137,60
-----------	--	--------

**Adaptateur 1/4"-3/8"-1/2"-3/4"-1.1/4"**

862009000	Adaptateur automatique	133,30
600011500	Adaptateur	32,00

**662 Filières réglables 4"**

662200100	1.1/2" - 4"	1.841,10
662200300	2.1/2" - 4"	1.645,65
662200500	1.1/2" - 3"	1.645,65
6621D2200	Jeu de peignes 1.1/2" - 2"	176,15
6622D2200	Jeu de peignes 2.1/2" - 3"	176,15
6623D2200	Jeu de peignes 3.1/2" - 4"	176,15
662300000	1.1/2" - 4"	1.593,55
662300100	2.1/2" - 4"	1.424,30
6621N2200	Jeu de peignes 1.1/2" - 2"	176,15
6622N2200	Jeu de peignes 2.1/2" - 3"	176,15
6623N2200	Jeu de peignes 3.1/2" - 4"	176,15

No.	Description	Prix €
-----	-------------	--------

**SUPERTRONIC® 1250**

866200000	1/2"-1.1/4" BSPT - 230 V	972,00
865200000	1/2"-1" BSPT - 230 V	820,15
866203000	1/2"-1.1/4" NPT - 230 V	929,10
865008700	Fixe-tubos	63,46

**SUPERTRONIC® 2000**

864220200	1/2"-2" BSPT - EU	1.990,80
864223200	1/2"-2" NPT - EU	1.990,80
864120200	1/2"-2" BSPT	1.763,15
1000001626	1/2"-1.1/4" - EU	1.125,30
864020000	Machine seulement	1.494,75
71280	Fixe-tubos	164,40

**Machine à fileter 2" Mod.215**

1500002913	NPT - 220 V	1.211,81
886420000	BSPT - 220 V	1.543,80

Filière automatique

1500003353	NPT 1/2"-2"	188,51
1500002157	1/2"-2"	283,25

**Machine à fileter 4" Mod.415**

1500001486	BSPTB - 220V	3.144,50
1500001591	NPT - 220V	3.102,20

Filière automatique

1500002158	BSPT 1/2" - 2"	365,35
1500002752	BSPT 2.1/2" - 4"	541,75
1500002159	NPT 2.1/2" - 4"	1.011,45
1500003352	NPT 1/2" - 2"	228,53

No.	Description	Prix €
-----	-------------	--------

**Machine à fileter HEAVY WORK 1/2" - 2"**

890000200	BSPT 1/2"-2"	2.802,60
8900N0200	NPT 1/2"-2"	4.589,75

Accessoires

890051000	Lame coupe-tube	26,60
890033100	Jeu de griffes avant	74,75
890033900	Porte griffes avant	145,65
890010900	Charbons	31,56
890023700	Interrupteur	18,19

**Machine à fileter HEAVY WORK 1/2" - 4"**

891000400	BSPT 1/2"-4"	6.672,05
-----------	--------------	----------

Accessoires

897072800	Lame coupe-tube	31,35
894026900	Jeu de griffes avant	143,60
897030900	Porte griffes avant	327,75
897035900	Interrupteur	27,70

**Jeu de peignes pour Mod. 215-2" y Mod. 415-4"**

4 peignes 1/2" - 3/4" - Section 27 x 9,5 mm		
886427000	BSPT	64,50
1000003246	BSPT HSS	145,71
886428000	NPT	64,95
4 peignes 1" - 2" - Section 27 x 9,5 mm		
886427100	BSPT	64,50
1000003245	BSPT HSS	138,82
886428100	NPT	64,95
4 peignes 2.1/2"-4" - Section 22,20 x 15,80 mm		
1000001450	BSPT	192,25
1000003247	BSPT HSS	228,39
1000001451	BSPT	190,30
1000001453	BSPT HSS	256,30

Jeu de peignes pour Heavy Work 2" y 4"

4 peignes 1/2" - 3/4" - Section 27 x 10 mm		
891060200	BSPT	245,70
891060597	NPT	223,75
4 peignes 1" - 2" - Section 27 x 10 mm		
881060100	BSPT	182,10
881060397	NPT	227,60
4 peignes 2.1/2"-4" - Section 20 x 14 mm		
894070697	BSPT	407,40
894070897	NPT HSS	248,53

1

No.	Description	Prix €
		

Huile de filetage

899100100	Spray Minérale. 600 ml	15,40
SEH020600	Minérale 5 l.	56,50
899200100	Spray Synthétique. 600 ml	16,65
SEH020200	Synthétique. 5 l.	72,00



Support pour tubes 12"

1500003161		184,73
------------	--	--------



887 Accessoire RO-GROOVER 6"

887090200	Pour Heavy Work 2"	1.195,20
887090800	Pour Heavy Work 4"	1.771,85
887092000	Pour SUPERTRONIC 2000	1.710,40

Molette et axe de rainurage

887090500	1"	501,30
887090600	1.1/4"-1.1/2"	520,85
887090700	2"-6"	378,75

Base de montage de recharge

56510	Pour SUPER-EGO 2"	62,22
56512	Pour SUPER-EGO 4"	63,02
887A91000	Pour Heavy Work 2"	59,37
56515	Pour SUPERTRONIC 2000	49,94



**Rainureuse électrohydraulique
ROGROOVER 2-12"**

1500001987	EU 230V 50Hz	3.572,85
Accessories		
887307000	Jeu molette supérieur 2"-8"	619,30
887308000	Jeu molette supérieur 3"-8"	422,40
887309000	Jeu molette supérieur 8"-12"	383,20
1500000133	Support manuel 2»-12"	494,10

No.	Description	Prix €
		

716 Coupe-tube MINI PRO

716200000	16 mm - 5/8" Cu-Al	17,15
735000500	5 lames Cu-Al	4,45
735001500	5 lames SS	8,50
70041	Axe	3,95



722 Coupe-tube MINI PRO

722200000	22 mm - 7/8" Cu-Al	18,05
P002D0300	722 x 20 + 73500500 x 20	348,10
735000500	5 lames Cu-Al	4,45
735001500	5 lames SS	8,50
70041	Axe	3,95



722 Coupe-tube MINI PRO

722100000	22 mm - 7/8" Cu-Al	19,15
735010500	5 lames MLP	10,30
735001500	5 lames SS	8,50
70041	Axe	3,95



728 Coupe-tube MINI-MAX PRO

728000000	28 mm - 1.1/8" Cu-Al	27,40
735000500	5 lames Cu-Al	4,45
735010500	5 lames MLP	10,30
735001500	5 lames SS	8,50
70041	Axe	3,95



725 Standard Coupe-tube PRO

725200000	30 mm - 1.1/8" Cu-Al	23,55
735000500	5 lames Cu-Al	4,45
735010500	5 lames MLP	10,30
735001500	5 lames SS	8,50
763012200	5 lames PP-PE	8,50
70041	Axe	3,95



726 Coupe-tube PRO

726000000	50 mm - 2" Cu-Al x 2	39,20
726020000	50 mm - 2" Cu-Al + PP, PE	36,55
735000500	5 lames Cu-Al	4,45
735010500	5 lames MLP	10,30
735001500	5 lames SS	8,50
763012200	5 lames PP-PE	8,50
70006	Axe	3,30

No.	Description	Prix €
		

735 Coupe-tube

735000000	35 mm - 2" Cu-Al x 2	51,10
735050000	35 mm - 2" Inox x 2	43,45
735000500	5 lames Cu-Al	4,45
735001500	5 lames SS	8,50
763012200	5 lames PP-PE	8,50
735010500	5 lames MLP	10,30
21652	Reamer	5,30
735002300	Lame d'ébavurage SS	6,65
70041	Axe	3,95



742 Télescopique Coupe-tube

742000000	42 mm - 1.5/8" Cu-Al	61,15
74200ZB00	742 + Inox + MLP	68,00
735000500	5 lames Cu-Al	4,45
735001500	5 lames SS	8,50
763012200	5 lames PP-PE	8,50
735010500	5 lames MLP	10,30



750 Automatique Coupe-tube

750000000	67 mm - 1.1/8" Cu-Al x 2	126,20
750010000	67 mm - 1.1/8" PP, PE x 2	129,95
735000500	5 lames Cu-Al	4,45
735010500	5 lames MLP	10,30
763012200	5 lames PP-PE	8,50
70042	Axe	4,25
751004100	Lame d'ébavurage	10,75



751/752 Automatique Coupe-tube

751020000	127 mm - 5" PP, PE	237,10
751010000	127 mm - 5" PP, PE	230,35
751000000	127 mm - 5" Cu, Al	237,10
752030000	168 mm - 6.5/8" PP, PE	266,75
737000500	8 lames Cu-Al	11,40
737012200	8 lames PP-PE 40 Ø	17,25
737032200	8 lames PP-PE 30,5 Ø	16,50
738012200	8 lames PP-PE 45 Ø	29,00
70042	Axe	4,25
751004100	Lame d'ébavurage	10,75

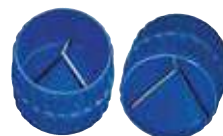

Ebavureur interne/externe

1500002738	Ø 4-40 mm (1/8"-1.5/8")	4,20
------------	-------------------------	------

No.	Description	Prix €
-----	-------------	--------



701/710 Coupe-tube pour fer

701010000	42 mm - 1.1/4" Fe	88,50
701020000	60 mm - 2" Fe	116,15
710040000	115 mm - 4" Fe	314,90
701010500	5 lames Fe 1.1/4"	9,50
710020500	5 lames Fe 2"	11,65
710021500	5 lames INOX 2"	2,89
710040500	3 lames Fe 4"	19,90
701011500	Axe 1.1/4"	12,25
70064	Axe 4"	5,30
70053	Axe 2"	3,75



ROCUT 26 TC		
568060000	ROCUT 26 TC	35,00



ROCUT 32 TC		
568400000	ROCUT 32 TC	53,55
568400300	Lame	17,45



ROCUT 42 TC		
568020000	ROCUT 42 TC	73,60
S00520000	Présentoir de table 10 uds.	700,35
568022400	Lame	36,35



ROCUT 50 TC		
568050000	ROCUT 50 TC	80,95
568052400	Lame	51,15

No.	Description	Prix €
-----	-------------	--------



ROCUT 63 TC		
568630000	ROCUT 63 TC	142,75
568632400	Lame	54,65



ROCUT 75 TC		
568750000	ROCUT 75 TC	223,65
568752400	Lame	85,05



ROCUT 32 "ECO"		
568B10000	ROCUT 32 "ECO"	19,75



ROCUT 42 "ECO"		
568B20000	ROCUT 42 "ECO"	22,25



Ressort à cintrer 769		
25190	1/2"	3,70
25186	5/8"	4,90
25182	10 mm	2,40
25183	12 mm	3,25
25185	15 mm	4,25
25186	16 mm	4,90



Pince à cintrer 761		
761000000	6 - 8 - 10 mm	32,70
761020000	1/4" - 5/16" - 3/8"	37,75

No.	Description	Prix €
-----	-------------	--------



Pince à cintrer 760

760080000	5/16"	74,35
760160000	5/8"	130,90
760060000	6 mm	69,20
760080000	8 mm	74,35
760100000	10 mm	86,85
760120000	12 mm	91,85
760140000	14 mm	115,80
760150000	15 mm	124,65
760160000	16 mm	130,90
760180000	18 mm	162,70



Pince à cintrer 765

765100000	10 mm	63,65
765120000	12 mm	67,30
765140000	14 mm	75,25
765160000	16 mm	98,45
765180000	18 mm	109,60



Pince à cintrer PRO

767050000	1/2"	110,95
767750000	3/4"	158,25



Cintreuse hydraulique manuelle

2" Plaque simple 3/8-1/2-1-3/4-1.1/4-1.1/2-2"		
1000001833	DIN2440-41 Court	1.567,25
1000001835	DIN2440-41 Long	1.567,25
2" Plaque double 3/8-1/2-1-3/4-1.1/4-1.1/2-2"		
1000001832	DIN2440-41 Court	1.567,25
1000001834	DIN2440-41 Long	1.567,25
3" Plaque double. Trépied pas inclus		
1500002308	1/2-1-3/4-1.1/4-1.1/2-2-3" DIN2440-41 Long	2.307,40

1

No.	Description	Prix €
		
	Cintreuse hydraulique manuelle 3/8" - 2"	
	2" Plaque double 3/8-1/2-1-3/4-1.1/4-1.1/2-2"	
100000757	DIN2440-41 Long	1.252,30



Formes rayon court		
57985	3/8"	27,70
57986	1/2"	29,60
57987	3/4"	36,95
57988	1"	54,90
57989	1.1/4"	82,50
57990	1.1/2"	105,70
57991	2"	107,90



Diabolos		
772201200	Right	86,80
772201100	Left	90,55
Tripod		
57352		171,35



Cintreuse électroportative		
1200001367	Cintreuse électroportative	1.703,05
1000001532	12, 15, 18, 22, 28 mm.	2.185,50
1000001534	15, 18, 22, 28 mm.	2.119,00
1000001533	18, 22, 28 mm.	2.039,45
1000001538	1/2-5/8-3/4-7/8-1"	2.074,40
1000001537	20, 25, 32 mm.	2.002,85
1000001536	16, 20, 25, 32 mm.	2.331,20
1000001535	15, 18, 22 mm.	1.895,15
1000001540	12, 14, 16, 18, 22 mm + Trépied	2.362,85
995808400	Mallette	94,85
25748	Trépied	154,05
25743	Ensemble axe fixation	20,99



Set de formes O.D. (Cu, Al, SS Inox)		
25612	12 mm	93,70
25614	14 mm	109,00
25615	15 mm	109,00
25616	16 mm	109,00
25618	18 mm	142,50
25620	20 mm	143,70
25622	22 mm	170,70
25628	28 mm	310,65
Set de formes Conduit		
25616	16 mm	109,00

No.	Description	Prix €
25620	20 mm	143,70
25625	25 mm	310,65
25666	32 mm	377,50
Set de formes (Cu, Al, SS Inox)		
25652	1/2"	93,70
762955300	5/8"	109,00
25619	3/4"	143,70
762955700	7/8"	171,95
25625	1"	310,65
25626	1.1/8"	310,65
Set de formes (Steel pipe)		
762965100	(2440-41) 1/4"	110,50
762965200	(2440-41) 3/8"	143,70
25684	(2440-41) 1/2"	171,95
25685	(2440-41) 3/4"	286,15
4R Set de formes (Cu, MLP)		
1000001561	1.1/4"-32 mm	306,40
1000001563	1.3/8"-35 mm	441,00



Appareil à battre le collets 491-492		
491000000	3/16"-5/8"	64,75
492000000	4-14 mm	64,75
491030000	491 (dudgeon double) + 725000000	108,85
491050000	491 + 725000000	90,00
492030000	492 (dudgeon double) + 725000000	108,85
492050000	492 + 725000000	86,85



Appareil à battre le collets excentrique		
R22240200	1/8"-3/4"	152,10



Appareil à battre le collets pour plomb		
480010000		35,15



530 Pince à siphon		
530100000	10"	38,80
530102000	Sans mors en plastique	37,30



Pompe d'épreuve TP25		
V15000000	0-25 bar	222,10
1000000590	Kit de maintenance	19,00



Pompe d'épreuve RP50-S		
R6020000	0-60 bar	443,65
1000000591	Kit de maintenance	21,70



Pompe d'épreuve TP120		
1000001903	120 bar	339,15
1000002163	Kit de maintenance	23,55



Pompe d'épreuve électrique autoaspirante RP-PRO III		
V12100000	0-60 bar	979,35
R6112500	High pressure hose	20,60
1000001069	Kit de maintenance	19,00



Déboucheur à ventouse		
SEH0224		8,40



Furet déboucheur		
670020000	2 m 7 mm Ø	18,90
670050000	5 m 7 mm Ø	40,35

No.	Description	Prix €
-----	-------------	--------



Déboucheur domestique
SEH000200 | 128,15



Pompe de débouchage par eau
SEH0079 | 14,85



Déboucheur par à-coup d'air
1500000485 | 242,25

No.	Description	Prix €
-----	-------------	--------



Déboucheur
SEH004800 | 68,90



Déboucheur à tambour manuel/perceuse
1500000484 | 153,65



Déboucheur

SEH022700	DOMESTIC CLEANER 500 ml.	12,00
SEH022600	PROFESSIONAL CLEANER 750 ml.	13,80

No.	Description	Prix €
-----	-------------	--------



Déboucheur par eau à pression
SEH019000 | 2.241,00

Accessories

76089	Canule à 4 jets	95,50
-------	-----------------	-------

Leader

SUPER-EGO, leader depuis 75 ans dans la fabrication d'équipements et d'outils pour tube et soudage. Nous sommes le premier fabricant espagnol d'outils en exportations au monde entier.

Leader dans la technologie associée à nos produits, fruit d'investissements constants et importants dans nos installations, nos machines et nos procédés de production.

Avec l'apparition de nouveaux matériels et systèmes d'assemblage nous développons des outils spécifiques pour chaque travail, un processus d'amélioration continue qui nous permet d'offrir à nos clients et usagers une meilleure et plus vaste gamme de produits dans un secteur chaque jour plus compétitif.

1

No.	Description	Prix €
-----	-------------	--------

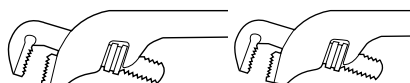

102 - 104 - 112

Machoire mobile



70200	8"	10,95
70201	10"	13,40
70202	12"	16,40
70203	14"	19,20
70204	18"	30,75
70205	24"	46,15
70206	36"	89,70
70207	48"	146,20
70208	60"	168,40

Ecrou



70180	8"	3,65
70181	10"	3,95
70182	12"	4,40
102140400	14"	5,10
70184	18"	7,10
70185	24"	10,85
70186	36"	20,00
70187	48"	30,70
1200001573	60"	46,59

Machoire mobile + Ecrou

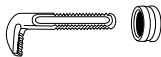

1300003658	6"	4,28
------------	----	------

Mors + axe



70189	6"	4,35
70190	8"	8,00
70191	10"	12,15
70192	12"	8,80
102141500	14"	8,35
70194	18"	10,70
70195	24"	14,10
70196	36"	23,05
70197	48"	30,70
70198	60"	43,21

Ensemble ressort



70170	8"	2,45
70171	10"	2,45
70172	12"	2,45
70173	14"	2,45
70174	18"	4,90
70175	24"	4,90
70176	36"	6,40
70177	48"	7,95
1000001669	60"	4,93



Ensemble de remplacement

102081000	8"	21,50
102101000	10"	31,50
102121000	12"	31,65
102141000	14"	34,70
102181000	18"	53,25
102241000	24"	75,65
102361000	36"	138,60

No.	Description	Prix €
-----	-------------	--------

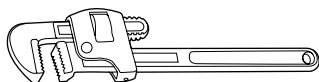

101

Cage+ressorts+axe



101100800	10"	11,15
101120800	12"	12,15
101140800	14"	16,20
101180800	18"	19,65
101240800	24"	21,75
101360800	36"	28,10

Machoire mobile

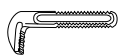

70374	8"	10,15
70375	10"	12,05
70376	12"	13,75
70377	14"	16,00
70378	18"	23,20
70379	24"	38,35
101360200	36"	62,70

Ecrou



101080400	8"	3,70
101100400	10"	3,95
101120400	12"	4,40
101140400	14"	5,15
101180400	18"	7,10
101240400	24"	10,85
101360400	36"	20,00

Ensemble ressort



101081100	8"	1,75
101101100	10"	1,75
101121100	12"	1,75
101141100	14"	1,75
101181100	18"	1,75
101241100	24"	1,75
101361100	36"	2,30

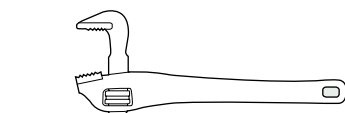

105

Machoire mobile



105140200	14"	19,90
105180200	18"	30,70



141 - 143 - 145

Ecrou



143050400	1/2"	3,25
141100400	1"	3,35
141150400	1.1/2"	3,80
14120D400	2"	5,45

No.	Description	Prix €
-----	-------------	--------



123

Sangle



123021000		17,00
-----------	--	-------



108

Sangle



70268	Pour 108010000 3"	17,85
70269	Pour 108020000 8"	19,55

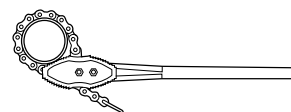

103

Jeu de machoire



103300200	1.1/2"	18,66
103311100	2.1/2"	53,85
103321100	4"	71,80
103331200	6"	91,05
103341200	8"	115,40
103351200	12"	192,50

Jeu de machoire



103301200	1.1/2"	2,45
103311200	2.1/2"	2,55
103321200	4"	3,70
103331300	6"	5,85
103341300	8"	12,00
103351300	12"	13,60

Chaîne + maillon d'union



70262	1.1/2"	30,70
70263	2.1/2"	48,70
70264	4"	64,00
70265	6"	165,80
70266	8"	213,15
70267	12"	318,40

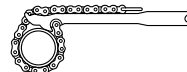

106 - 107

Chaîne pour



70239	107120000	39,80
-------	-----------	-------

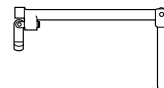





108



Machoire mobile

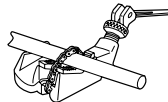
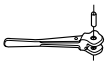

118010100	118010000	9,60
-----------	-----------	------

No.	Description	Prix €
		
400		
Jeu de chaîne		
400011300	1.1/2"	71,80
400021300	4"	94,85
400031300	6"	141,05
Poignée + écrou		
		
400011200	2.1/2"	35,90
400021200	4"	38,35
400031200	6"	74,40
Jeu de mors		
		
400011100	8"	33,35
400021100	4"	55,15
400031100	6"	71,80

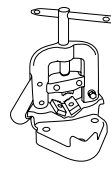
No.	Description	Prix €
		
404		
Levier		
404023000	2.1/2"-4"-6"	24,75
Levier		
		
70734	Mors 404-2.1/2"	23,40
70721	Mors 404- 4"	37,10
70722	Mors 404-6"	51,20
Jeu de chaîne		
		
70731	2.1/2"	53,85
70732	4"	84,70
70733	6"	123,15

No.	Description	Prix €
		
450		
Mors supérieur		
		
450020600	2"	11,05
450030600	3"	19,20
450040600	4"	21,25
Jeu d'ormes inférieur		
		
450022000	Jeu d'ormes inférieur 2"	19,75
450032000	Jeu d'ormes inférieur 3"	26,95
450042000	Jeu d'ormes inférieur 4"	35,90

Fabricant

Nous fabriquons des équipements et des outils pour tube et soudage avec les systèmes les plus modernes de fabrication (SMED, KAIZEN, KANBAN).

Nos outils bénéficient des derniers traitements de trempes (atmosphère contrôlée, induction et distension) qui leur confèrent une qualité reconnue et appréciée permettant de satisfaire les clients les plus exigeants du monde entier de l'industrie chimique, l'industrie du pétrole, l'industrie minière, etc.

Les meilleurs fabricants du monde font confiance à SUPER-EGO pour la fabrication des outils.



No.	Description	Prix €
-----	-------------	--------

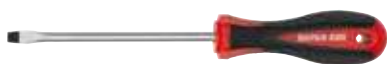

Tournevis bi-matière

SEH010000	3 x 75 mm	3,25
SEH010700	5 x 100 mm	3,70
SEH010900	5 x 150 mm	5,45
SEH011700	PH0 x 75 mm	4,10
SEH011900	PH1 x 100 mm	4,45
SEH012200	PH2 x 125 mm	4,90



Pack 2 Tournevis

1500000628		7,05
------------	--	------



Set de 6 tournevis

SEH009300		18,95
-----------	--	-------



Set de 6 tournevis de précision

SEH009400		13,35
-----------	--	-------



Set 44 pieces

SEH003100		39,80
-----------	--	-------



Tournevis SUPER-EGO

F09010600		20,45
-----------	--	-------

No.	Description	Prix €
-----	-------------	--------



Tournevis SUPER-EGO

F09010800		27,15
-----------	--	-------



Tournevis ERGO-MAX

F20236000	Pozidriv Set	32,85
F20235000	Philips set	31,65



Tournevis 12 en 1

F02023200	Pozidriv Set	13,75
-----------	--------------	-------



Set 3 tournevis d'électricien

1500000629	2 tournevis + tester	11,40
1500000671	4 tournevis + tester	22,50



Jeu d'embouts. 29 pcs.

SEH009600		13,25
-----------	--	-------



Jeu d'embouts. 100 pcs.

SEH001500		26,20
-----------	--	-------



Jeu d'embouts. 113 pcs.

SEH001600		40,35
-----------	--	-------

No.	Description	Prix €
-----	-------------	--------



Pincés

514010000	Universalle 160 mm	12,15
514010100	Universalle 180 mm	14,10
514010200	Universalle 200 mm	17,05
514011100	Coupe latéral 160 mm	10,75
514011200	Coupe latéral 180 mm	14,60
514010300	Bec rond 160 mm	10,50
514010400	Bec plat 160 mm	10,50
514011500	Coupe frontale 160 mm	16,20
514010500	Pour téléphones 160 mm	11,10
514010700	Pour téléphones 200 mm	12,50
514011000	Bec courbé 200 mm	13,05
514011400	À dénuder 160 mm	14,00



Pincés d'électricien

SEH004200	Universalle 160 mm	17,55
SEH004300	Coupante diagonale 160mm	16,95
SEH004400	Dénude-câbles 160 mm	18,30
SEH004500	Téléphones 160 mm	17,45
SEH009800	Téléphones 200 mm	17,95
SEH009900	Bec coulé 200 mm	17,70



Jeu de pincés

S51404000		36,90
-----------	--	-------



Jeu de pince multiprise + 2 pincés

S00260000		36,95
-----------	--	-------



Coffret de 6 minipincés

S51406000		24,05
-----------	--	-------



Mètre ruban ERGO-COLOUR

M31201400	3 m x 16 mm	1,90
M31201900	5 m x 19 mm	3,15

Mètre ruban ERGOCHROME

M31201600	3 m x 16 mm	2,65
M31201700	5 m x 18 mm	3,50

Mètre ruban ERGOCHROME

M31200800	3 m x 16 mm	2,20
M31200900	5 m x 19 mm	2,90
M31201800	8 m x 25 mm	6,10

Jeu de 3 limes

515000100		15,40
-----------	--	-------

Cutter 1 + 2 cuchillas

SEH024100	Cutter 1 + 2 lames	4,50
-----------	--------------------	------

Professionnel 1 + 7 lames

SEH024200		5,75
-----------	--	------

Professionnel 1 + 5 lames

SEH024300		10,15
-----------	--	-------

Cutter 1 + 10 lames trapèze

SEH024400		10,35
-----------	--	-------

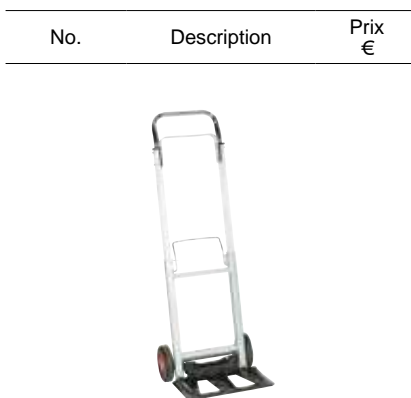
Diable Aluminium maxi 90 kgs

855092200		56,50
-----------	--	-------

Mini-scie

071203E		7,65
---------	--	------

Mini-scie

170000000		10,50
-----------	--	-------

Monture de scie PRO

170100000		15,25
-----------	--	-------

Lame de scie

SEH0229	Carbone 1"	0,90
1500000468	Carbone 1/2"	0,90
SEH0230	2 x Bimetal	2,30
SEH0240	Bimetal	2,20

Ciseaux multifonctions

565020000	202 mm	15,85
-----------	--------	-------

Ciseaux multifonctions

565020400	202 mm	14,20
-----------	--------	-------

Ciseaux universels

565020300	195 mm	13,40
-----------	--------	-------

Ciseaux d'électricien

565020200	144 mm	10,35
-----------	--------	-------

Ciseaux d'électricien bi-matériau

565020100	144 mm	9,30
-----------	--------	------

135 Clé à molette

135060000	6"	14,00
135080000	8"	15,10
135100000	10"	20,05
135120000	12"	25,60
135150000	15"	43,75

Clé à molette grande capacité

1500000670	8" 40 mm	15,65
SEH019200	10" 52 mm	22,10

Clés à fourche double, 8 PCS.

6-7-8-9-10-11-12-13-14-15-16-17-18-19-20-22 mm		42,35
SEH001000		

Jeu de clés polygonales. 8 PCS.

6-7-8-9-10-11-12-13-14-15-16-17-18-19-20-22 mm		45,15
SEH001100		

Jeu de clés mixtes. 12 PCS.

6-9-10-11-12-13-14-15-17-18-19-21 mm		42,95
SEH001200		

No.	Description	Prix €
-----	-------------	--------



Jeu de clés à cliquet. 8 PCS.
8-10-11-13-14-17-19-22 mm
SEH001300 | 64,40



Jeu de clés à cliquet articulés. 7 PCS.
8-10-11-13-14-17-19 mm
SEH001400 | 71,25



Coffret de douilles avec cliquet.
SEH000700 | 46 PCS. 1/4" | 65,15

No.	Description	Prix €
-----	-------------	--------



Coffret de douilles avec cliquet.
SEH000800 | 58 PCS. 3/8" | 106,90



Coffret de douilles avec cliquet
SEH000900 | 94 PCS. 1/4"-1/2" | 160,45

No.	Description	Prix €
-----	-------------	--------



Clés Allen
B40224300 | 1,5-6 mm Ø | 12,00
B40234300 | 2,5-10 mm Ø | 27,90



Clés Allen
B40121300 | 1,5-10 mm Ø Court | 10,45
B40121500 | 1,5-10 mm Ø Long | 14,45



Clés Allen
SEH003200 | 19,45

Innovation

Leader en R&D+I avec un puissant réseau d'importantes relations avec des centres technologiques, des fondations et des universités.

SUPER-EGO est constamment plongé dans un processus d'amélioration de nos produits pour offrir à nos clients une meilleure et plus vaste gamme dans un secteur chaque jour plus compétitif.

No.	Description	Prix €
-----	-------------	--------

**Chalumeaux SEGOFLAME**

3593000	SEGOFLAME	56,20
P00591000	SEGOFLAME + 3 BTP C200	66,25
1500001065	Cartouche BTP C200	2,55

**Chalumeaux SEGOFLAME PIEZO**

3593100	SEGOFLAME PIEZO	60,70
1500001065	Cartouche BTP C200	2,55
35561	Brûleur 22 mm Ø	19,50

**Chalumeaux MULTIFIRE**

SEH024700	MULTIFIRE	22,15
1000000419	MULTIFIRE + 2 BTP C200	40,85
SEH003800	Cartouche BTN 250	4,60

**Chalumeaux EASY-FIRE**

R3555300	EASY-FIRE	29,65
SEH020300	Cartouche BTP 300	7,80

**Chalumeaux SEGOFIRE**

1000001477	Chalumeau SEGOFIRE	27,65
3550100	SEGOFIRE + BTP 300	37,20
SEH020300	Cartouche BTP 300	7,80
223432200	Brûleur 22 mm Ø	11,15
254202300	Anneau caoutchouc (extérieur)	1,05
254201100	Joint torique (intérieur)	0,60

**Chalumeaux SEGOFIRE PIEZO**

254200000	SEGOFIRE PIEZO	45,80
3555500	SEGOFIRE PIEZO + BTP 300	55,90
P00555500	SEGOFIRE PIEZO + 3 BTP 300	73,40
35561	Brûleur PIEZO 22 mm Ø	19,50
SEH020300	Cartouche BTP - 300	7,80
254202300	Rubber ring (outside)	1,05
254201100	O-ring (inside)	0,60

No.	Description	Prix €
-----	-------------	--------

**Chalumeaux PRO-FIRE**

1500002771	PRO-FIRE	37,58
SEH024600	Cartouche ROMASSGAS US	26,30
263003400	Adaptateur US - EU	18,10

**Chalumeaux SUPER-FOGO**

254400000	SUPER-FOGO	33,15
263003400	Adaptateur US - EU	18,10
SEH024600	Cartouche ROMASSGAS	26,30

**Compact Chalumeaux POWER-FIRE**

254800000	Chalumeaux USA	114,30
254800100	Chalumeaux USA + ROMASSGAS US	135,65
SEH024600	ROMASSGAS US	26,30
263003400	Adaptateur US - EU	18,10
254707800	Brûleur 22 mm Ø	8,75

**Disposable gas Cartouches**

SEH024600	Cartouche ROMASSGAS US	26,30
SEH020300	Cartouche BTP 300	7,80
1500001065	Cartouche BTP C200	2,55
SEH003800	Cartouche BTN 250	4,60

**Chalumeaux AIRPROP®**

P00408900	W21,8L" - R3/8"L - 2 m	87,95
253250100	R3/8"L - R3/8"L - 2,5 m	81,55

**Chalumeaux TURBOPROP®**

P00109200	W21,8L" - R3/8"L - 2 m	100,75
-----------	------------------------	--------

No.	Description	Prix €
-----	-------------	--------

**Chalumeaux AIRPROP® PLUS**

P00508900	W21,8L" - R3/8"L - 2 m	98,25
253250200	R3/8"L - R3/8"L - 2,5 m	102,35
253031600	Nipple	76,05

**Roofing Chalumeaux ROMINI**

253500100	ROMINI	63,60
-----------	--------	-------

**Chalumeaux raccord à tige**

253030300	35 mm Ø. L= 200 mm.	68,30
1000000538	63 mm Ø windproof. L= 600 mm	83,15
253030200	28 mm Ø. L= 100 mm.	79,60
253031100	63 mm Ø. L= 600 mm.	82,50
253031200	57 mm Ø. L= 600 mm.	85,55

**Brûleurs standard**

223012200	22 mm Ø	19,80
223012800	28 mm Ø	20,80
223013200	32 mm Ø	24,15
223013500	35 mm Ø	26,00

**Brûleurs de chauffe**

223014500	45 mm Ø	29,40
223015100	51 mm Ø	36,05
223015700	57 mm Ø	40,00
223016300	63 mm Ø	40,00

**Brûleurs de chauffe anti-vent**

223213500	35 mm Ø	28,60
223214500	45 mm Ø	29,40
223215100	51 mm Ø	32,00
223215700	57 mm Ø	37,40
223216300	63 mm Ø	40,00

No.	Description	Prix €
		
Lances		
231010000	100 mm	15,80
232010000	200 mm	17,50
233510000	350 mm	20,45
236010000	600 mm	19,70

		
Buses AIRPROP® pour brasage tendre et fort		
221111900	19 mm Ø	40,00
221112200	22 mm Ø	44,10

		
Buses TURBOPROP® pour brasage tendre et fort		
221011000	10 mm Ø	32,00
221011200	12 mm Ø	34,70
221011500	15 mm Ø	36,05
221011800	18 mm Ø	40,00
221012400	24 mm Ø	49,55

No.	Description	Prix €
		
Manches M 14x1 - R3/8"L		
212111100	Régulateur de gaz	32,00
212114100	Régulateur de gaz. Avec tige	35,65
211111100	Gas & flame regulator + trigger	45,35
211114100	Gas & flame regulator + trigger. With spigot	53,35
211115300	Gas & flame regulator + large trigger	45,30

		
Tuyaux flexibles		
251232200	2,5 m	34,70
1000000946	2 m	28,00
251266200	5 m	50,85

Acétylène		
251322200	2 m	41,80
240140000	Hexagonal nut	3,85
990100100	Nipple 6,3 mm Ø int.	3,05
210013000	Nipple 8 mm Ø int.	7,95

		
Supports		
252010000	Support pour chalumeau	2,55
252011100	Support pour bras	14,00

No.	Description	Prix €
		
Robinet de réglage de pression 10 kg/h		
242206000	R 3/8" L	42,75
242203000	POL 7/8" L metallic gasket	45,35

		
Socket Welder		
1500000447	20, 25, 32 mm Ø 230V	223,45
1500000448	20,25,32,50,63 mm Ø 230V	245,10
1500000449	75, 90, 110 mm Ø 230V	365,35

		
Matrices		
1500000687	20 mm	18,65
1500000688	25 mm	20,05
1500000689	32 mm	23,20
1500000690	40 mm	38,05
1500000713	50 mm	42,20
1500000691	63 mm	62,75
1500000692	75 mm	78,50
1500000693	90 mm	109,80
1500000694	110 mm	156,95

3

Qualité

Depuis 1994, SUPER-EGO dispose de la certification TUV Nord pour les normes ISO 9000 (assurance de la qualité dans la conception, la fabrication, la distribution et le service après-vente de nos équipements et outils) et ISO 140001 (application du principe de prévention et d'amélioration continue dans la gestion environnementale), normes qui ont été renouvelées périodiquement jusqu'à ce jour.



No.	Description	Prix €
-----	-------------	-----------

**Pompes à vide SEGO VAC**

1500002662	SEGO VAC 1.5 R32	207,57
1500002663	SEGO VAC 3.0 R32	310,35
1500001501	SEGO VAC 6.0	346,39

**Unité de récupération de réfrigérant SEGO RECV R32**

1500002664	SEGO RECV R32	827,62
------------	---------------	--------

**Manomètres analogiques SEGO MANFL**

1500002235	1/4" SAE - 2 voies	50,73
1500001403	1/4" SAE - 4 voies	91,05
1500002840	5/16" SAE - 2 voies	62,46
1500002665	5/16" SAE - 4 voies	66,54

**Jeu 3 tuyaux flexibles haute pression SEGO HS PRO**

1500001406	5/16" SAE	45,07
1500002841	5/16"-1/4" SAE	44,10
1500001407	1/4" SAE	44,50

**Tuyau flexible haute pression SEGO HS PRO**

1500002842	5/16" SAE	14,51
------------	-----------	-------

No.	Description	Prix €
-----	-------------	-----------

**Kit manomètre analogique 4 voies + jeu 3 tuyaux flexibles haute pression SEGO KIT MANFL**

1500001404	R410A	105,76
1500001405	R22 R134A R407C R404A	104,07
1500002666	R32 R410A	116,12

**Balance SEGO SCL**

1500001401		253,05
------------	--	--------

**Thermomètre numérique SEGO TRM**

1500001410		20,66
------------	--	-------

**Détecteur électronique SEGO DTCTR**

1500001409		215,30
------------	--	--------

**Dudgeonnière universelle**

1500001408	1/4", 5/16", 3/8", 1/2", 5/8", 3/4"	60,41
------------	-------------------------------------	-------

**Dudgeonnière universelle**

R22240200	1/8" - 3/4"	152,10
-----------	-------------	--------

No.	Description	Prix €
		
Pompes submersibles. Eaux claires		
1500002288	SEGO BLS-60. 6.000 L/H	78,95
1500002289	SEGO BLS-90. 9.000 L/H	81,85
1500002290	SEGO BLS-110i. 11.000 L/H	134,20
1500002291	SEGO BLS-55. 5.500 L/H	170,20
RP1400000	Service continu ULTRA 3000	132,95

		
Pompes submersibles. Eaux chargées		
1500002292	SEGO BTS-90 9.000 L/H	103,55
1500002293	SEGO BTS-135 13.500 L/H	119,50
1500002294	SEGO BTS-155 15.500 L/H	161,00
1500002295	SEGO BTS-155i 15.500 L/H	128,40
1500002296	SEGO BTS-250i 25.000 L/H	164,25

		
Pompes pour bassins		
1500002301	SEGO BFS-14. 900 L/H	68,40
1500002302	SEGO BFS-26. 3.000 L/H	107,10
1500002303	SEGO BFS-36. 3.600 L/H	128,60

		
Pompe de surface		
1500002297	SEGO BJS-300. 3.000 L/H	167,55
1500002298	SEGO BFS-420. 4.200 L/H	183,90

		
Kit d'aspiration d'eau 1"		
1500002305	VCP-TRONIC	78,20

		
Groupe de pression		
1500002299	TPS-360	213,10
1500002300	TPS-450	275,95

No.	Description	Prix €
		
Réchaud portable		
1500003888	Réchaud portable	32,25
SEH003800	BTN 250	4,60

		
Réchaud à gaz pour usage en plein air		
SEH024800	Réchaud à gaz	61,45

		
Réchaud de camping		
SEH025300	Réchaud de camping	24,80
1500001065	BTP C200	2,55

		
Lampe de camping		
1500004425	Lampe de camping	21,29
1500001065	BTP C200	2,55
1500000424	3 Manchons	5,20
1500000423	Verres	3,70

		
Réchaud de camping pour butane		
1500000590	Réchaud de camping pour butane	13,40

		
Programme		
SD1000100	SEGO-TIMER	41,05

		
Connecteur robinet		
SD5000800	1/2" - 3/4"	1,45
SD5000900	3/4" - 1"	1,65

No.	Description	Prix €
		
Connecteur automatique		
SD5000200	1/2" - 5/8" (12 - 15 mm.)	2,20
SD5000300	5/8" - 3/4" (14 - 19 mm.)	2,55
Connecteur automatique. AQUASTOP		
SD5000400	1/2" - 5/8" (12 - 15 mm.)	2,45

		
Reparateur de tuyau		
SD5000600	1/2" - 5/8" (12 - 15 mm.)	1,45
SD5000700	5/8" - 3/4" (14 - 19 mm.)	2,15

		
Lance d'arrosage		
SD5001100	Lance	2,90
SD5001200	Lance + set	8,80

		
Pistolet multifonction		
SD5001000	Pistolet	10,30
SD5004700	Pistolet + set	11,95

		
Douche de jardin ajustable avec trépied		
SD5000100		35,60

		
Kit d'arrosage en spirale		
SD3000100	EVA	25,70
SD3000300	PU	56,35

No.	Description	Prix €
-----	-------------	-----------



Enrôleur automatique

SD2000200	10 m.	79,45
SD2000100	20 m.	142,60



Support de tuyau d'arrosage assemblé		
SD5004000		59,90

No.	Description	Prix €
-----	-------------	-----------



Support de tuyau d'arrosage mobile équipé		
SD5004800		64,10

No.	Description	Prix €
-----	-------------	-----------



Support de tuyau mobile		
SD5001500		40,05



Point de Vente

Nous mettons à votre disposition pour toute notre gamme de produits. Vous pourrez exposer les produits d'une façon attractive et ainsi augmenter ses ventes.

Nous vous offrons des exposeurs pour le comptoir pour quelques outils ainsi que des vitrines qui puissent créer une area Super-Ego dans votre magasin.

Consultez s'il vous plait les options disponibles.



SUPER-EGO

SUPER-EGO TOOLS, S.L.U.
Ctra. Durango-Elorrio, km. 2
48220 - Abadiano SPAIN

E-mail: super-ego.france@super-ego.es
Bureau: + 33 (0) 3 87 74 00 54

www.super-ego.com